

Child's Double-sided Easel



Material List

- 1 ea. 2' X 4' sheet 1/4" hardboard
- 1 ea. 1' X 2' sheet 1/4" plywood
- 4 ea. 1 X 2 X 48" S4S fir or equivalent
- 1 ea. 1 X 2 X 24" S4S fir or equivalent
- 1 ea. 1 X 4 X 18" S4S fir or equivalent
- 1 ea. 3/4" X 22" dowel
- 1 ea. 1/4" axel pin
- 2 ea. 3/16" X 1 1/2" stove bolts, wing nuts and flat washers
- 4 ea. 3/4" # 6 round head wood screws
- 10 ea. 1" #8 round head wood screws
- 2 ea. 1 3/4" round head wood screws
- Blackboard paint

Step 1

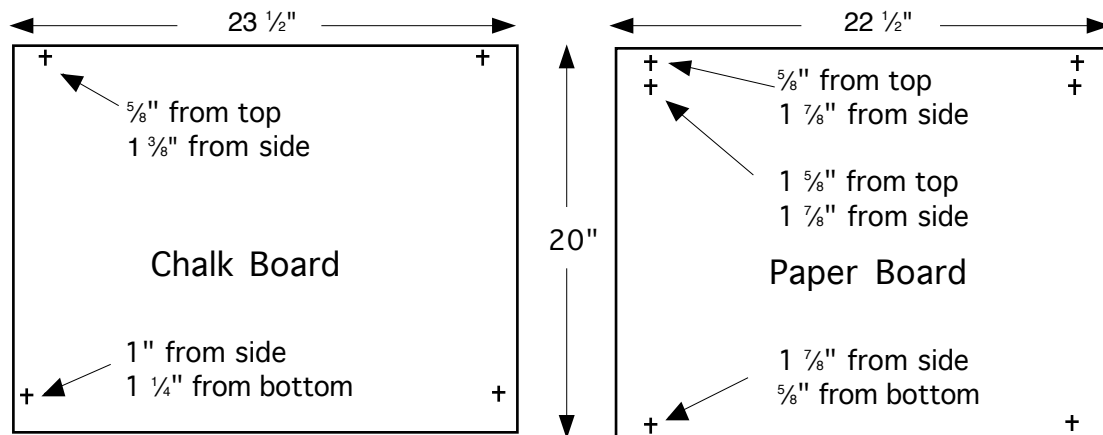

Cut the two boards to size from the 1/4" hardboard, drill 5/32" holes as indicated, round all corners and edges, paint the Chalk Board with blackboard paint as per instructions on the can.

Step 2

Cut the four 1 X 2 legs to 47" long, measure 7/8" from end and drill 7/8" holes in all four legs and 1/4" hole in the end of one as shown for axel pin.

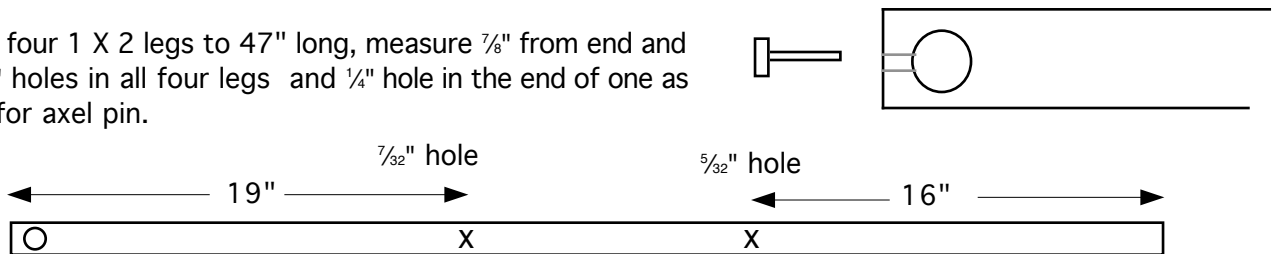

Select two of the legs that don't have the 1/4" hole drilled in the end for the paper board side and drill as shown above. Round corners on both ends of all four legs.

Mendoc Media ©

Double-sided Easel
Plan # 103

plans@benchnotes.com

Page 1

Step 3

Rip five strips 1 ¼" X 24" from the sheet of ¼" plywood. Cut two of these 18" long, round top corners and sand edges, glue on each side of 1X4 for paint shelf.

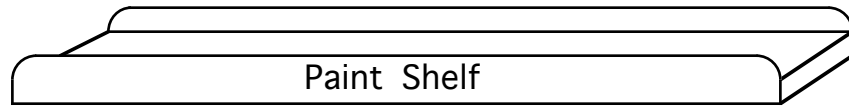

Cut short 1X2 and one ¼" strip to 23 ½" long, round top corners and glue to edge of 1X2 for chalkboard ledge.

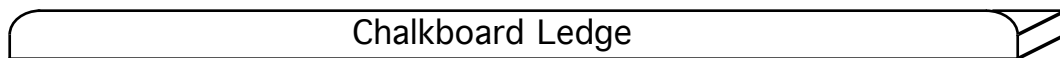

Cut ¼" strip 19 ¾" long, drill 7/32" dia. holes ½" from each end, round corners and sand edges for paper bar.

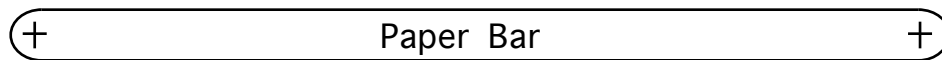

Cut two strips 10 ¾" long for leg braces, drill, cut slot and round corners as shown below.

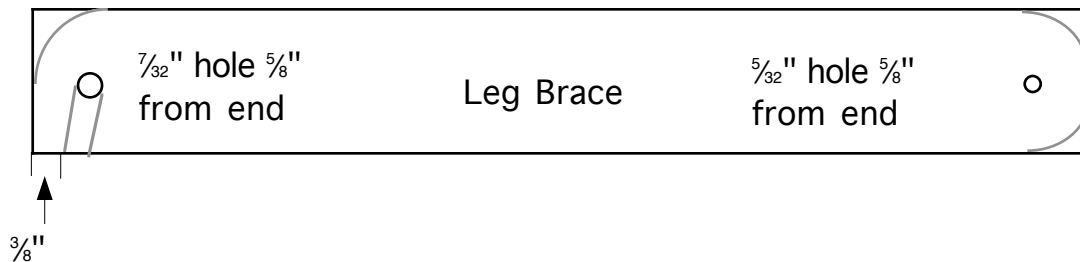

Step 4

Drill 5/16" hole 3/4" from end of 3/4" dowel

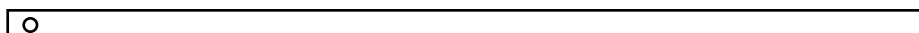

Step 5

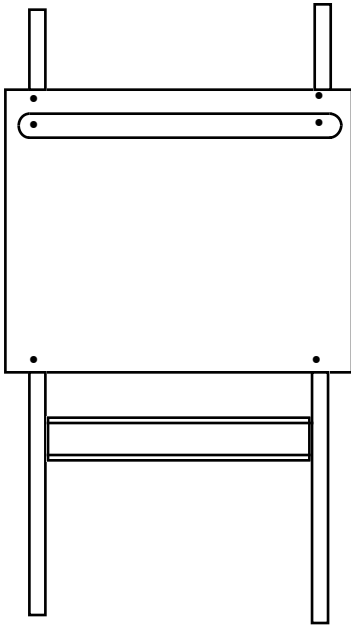

Install paint shelf between paper side legs with 1 3/4" long screws into center of 1X4, do not tighten, turn flat as shown until easel is assembled. Fasten Paper hardboard to legs 5" from top, aligning pre drilled holes with center of edge of legs with 1" long screws in the two top holes and two bottom holes. Fasten paper bar with 1" long screws, do not tighten as paper must be able to pass through behind it.

Step 7

Insert the 1 1/2" stove bolts through the paper side legs from the inside, put washers on and start wing nuts. Assemble the two halves by inserting the dowel and axel pin, then slip slots in leg braces over bolts and tighten wing nuts. Remove paint tray screws one at a time adding glue between end of shelf and leg. Position shelf so it is level and tighten screws.

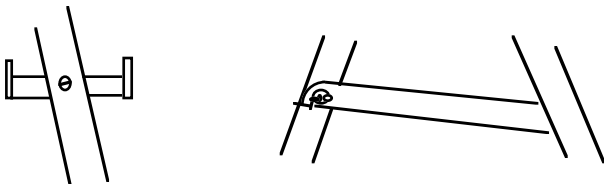

Step 8

Finish wooden parts with a protective finish.

Step 6

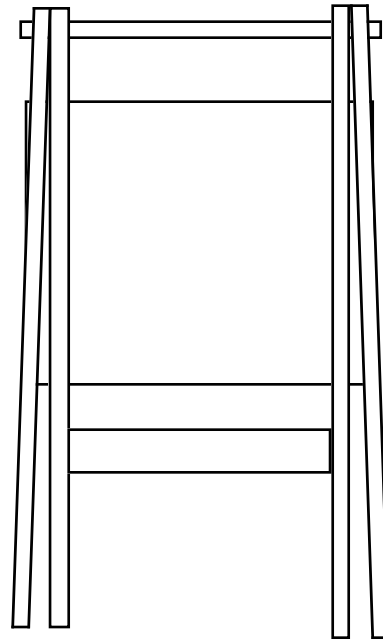

Flip assembled paper side over, slip dowel through holes, then slip blackboard legs onto dowel so they taper out as shown. Place blackboard on legs 5" from top, align pre drilled holes with center of edge and fasten with 1" long screws. Remove dowel, lift and flip assembly over. Fasten leg braces to inside face of legs with slot facing blackboard side, 20" from top of legs. Fasten chalkboard ledge to bottom edge of blackboard with the four 3/4" X #6 screws.

Notes

Condition the blackboard by rubbing a piece of chalk on edge over the entire surface of the board, then erase.

You can purchase rolls of shelf lining paper, or ask a printing company for butt rolls. Putting these on the easel will make it top heavy so rewind several yards of paper on to an empty food wrap core (have someone hold the butt roll on a broom handle).

Feed paper behind paper bar, pull down and fasten bottom edge with masking tape, to remove drawing hold paper bar down with one hand and tear.